

Características

- 1 Olhal Içamento
- 2 Alavanca Acionamento de Descarga
- 3 Abertura da Descarga Central
- 4 Calha de Descarga
- 5 Placa de Identificação
- 6 Funil c/ Mangueira
- 7 Encaixe p/ Manipulador



Acompanha Manual Técnico, Memorial de Cálculo e ART

Acessórios Disponíveis (Não Inclusos)

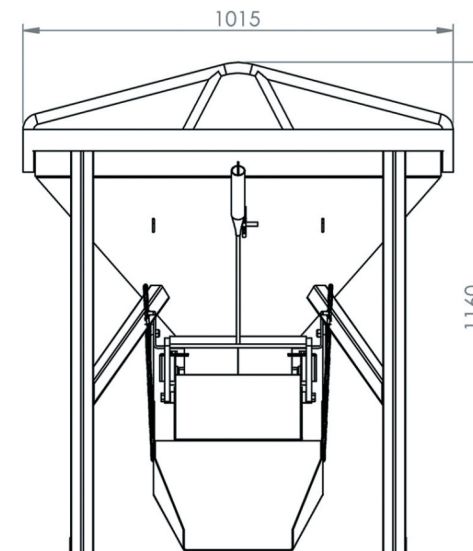
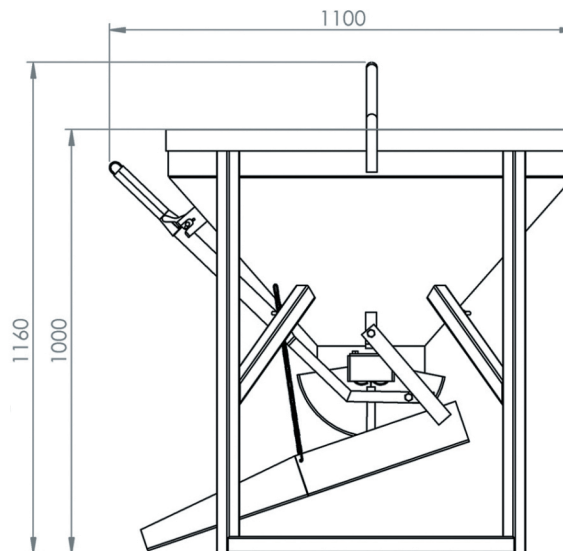
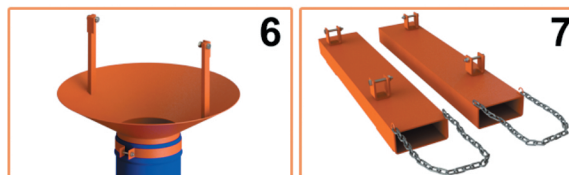

Medidas para Transporte:
C1100xL1015xA1160

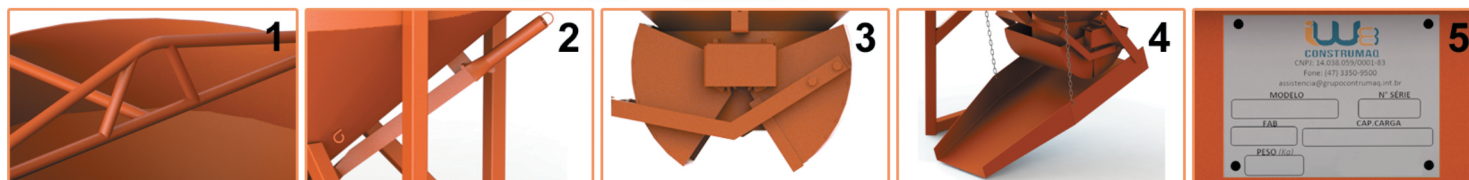

5703 BALDE DE DESCARGA CENTRAL

Capacidade
300 Litros

Carga
705 Kg

Peso
84 Kg

Acabamento
Pintura Eletrostática

Cor
Laranja

Matéria Prima
Aço

ART - PROJETO E FABRICAÇÃO VINCULADO AO CREA

