

## Características

- 1 Olhal Içamento
- 2 Alavanca Acionamento de Descarga
- 3 Abertura da Descarga Central
- 4 Calha de Descarga
- 5 Encaixe p/ Manipulador
- 6 Placa de Identificação
- 7 Funil c/ Mangueira

Acompanha Manual Técnico, Memorial de Cálculo e ART

Acessórios Disponíveis ( Não Inclusos )

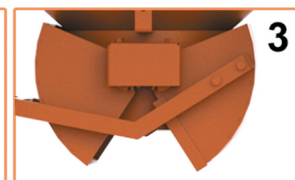
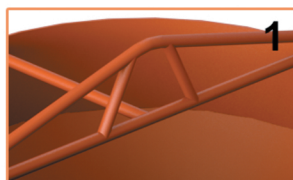
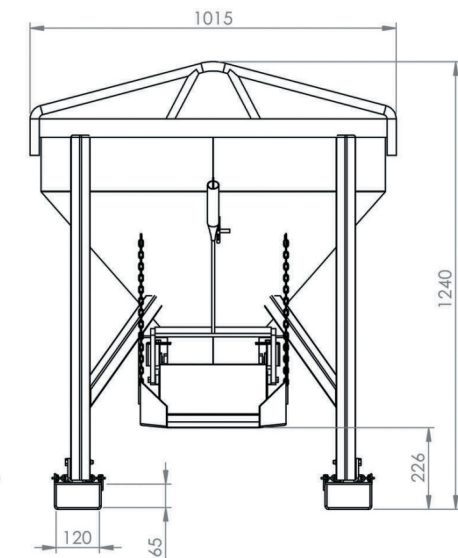
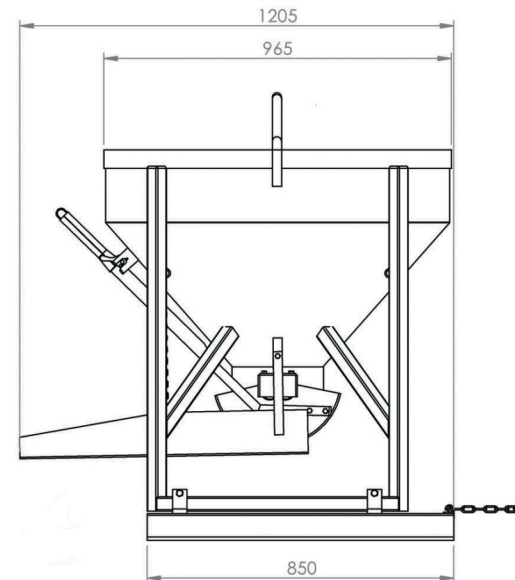

Medidas para Transporte:  
C1205xL1015xA1240

## 6062 BALDE DE DESCARGA CENTRAL

Capacidade  
300 Litros

Carga  
705 Kg

Peso  
120 Kg

Acabamento  
Pintura Eletrostática

Cor  
Laranja

Matéria Prima  
Aço

ART - PROJETO E FABRICAÇÃO VINCULADO AO CREA

