

Características

- 1 Olhal Içamento
- 2 Alavanca Acionamento de Descarga
- 3 Abertura da Descarga Central
- 4 Calha de Descarga
- 5 Placa de Identificação
- 6 Funil c/ Mangueira
- 7 Encaixe p/ Manipulador

Acompanha Manual Técnico, Memorial de Cálculo e ART

Acessórios Disponíveis (Não Inclusos)

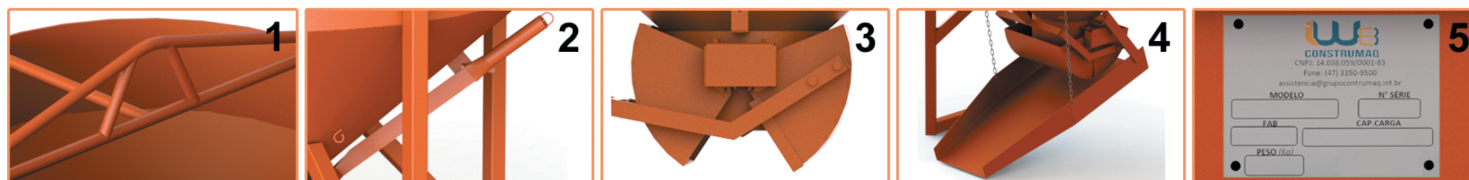
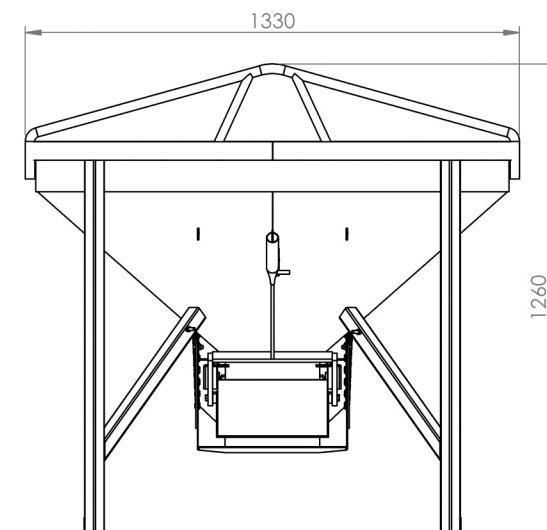
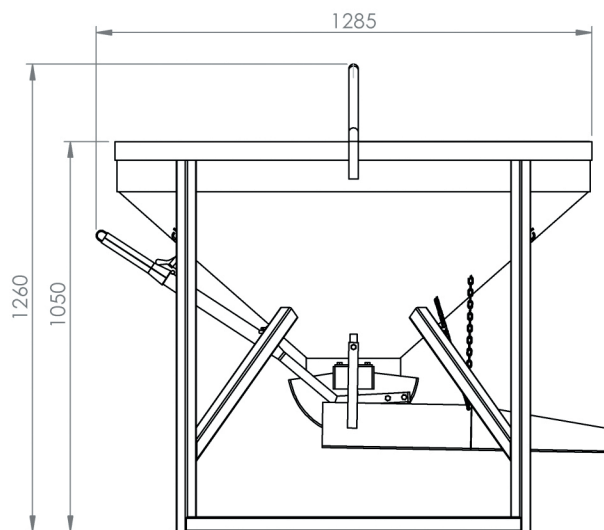
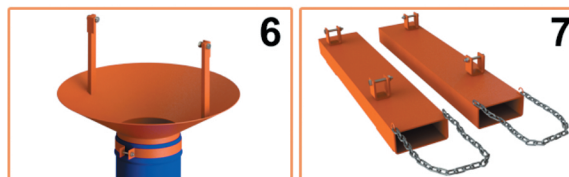

Medidas para Transporte:
C1285xL1330xA1260

5713 BALDE DE DESCARGA CENTRAL

Capacidade
400 Litros

Carga
940 Kg

Peso
100 Kg

Acabamento
Pintura Eletrostática

Cor
Laranja

Matéria Prima
Aço

ART - PROJETO E FABRICAÇÃO VINCULADO AO CREA

